



PIT-RADWAR S.A.
WROCLAW DIVISION

50-425 Wrocław, ul. Krakowska 64, Poland
 tel. (+48) 71/342-65-54, fax (+48) 71/342-58-59
 e-mail: sales@dolam.pl
 www.dolam.pl

Reed relays type K-9/Nx1

This product is in accordance with RoHs

**Reed relays with 1 to 4 form A contacts
 (normally open) for PCB's.**

PARAMETERS	Unit	TYPE
		K-9/Nx1

1. CONTACT PARAMETERS

Switching power	max	W, VA	10
Switching voltage	max	V _{DC}	200
Switching current	max	A	0,5
Contact resistance	max	mA	200
Life expectancy at 20V _{DC} , 500mA		operations	3x10 ⁶

2. RELAY PARAMETERS

Operating voltage range		V	see p. 3
Coil resistance		A	see p. 3
Operate time incl. bounce time for:			
K-9 / 1 x 1			1,2
K-9 / 2 x 1	max	ms	1,5
K-9 / 3 x 1			1,8
K-9 / 4 x 1			2,1
Release time	max	ms	0,3
Test voltage.:			
contact			300
contact/ contact			500
contact/ coil	min	V _{AC}	500
contact/ shield			500
coil/ shield			500
Insulation resistance	min	A	10 ⁹
Admissible ambient temperature			-40°C ÷ 70°C

3. LIST OF COILS AND OPERATING VOLTAGE RANGE

Symbol of relay	Contact arrangement	Index No	Coil resistance R _N [A] t = 20°C	Supply voltage, t = 20°C		
				U _N [V]	U _{MIN} [V]	U _{MAX} [V]
K-9/1x1	1 form A	8-4441-831-1	265 ± 15%	6	4,3	12,5
K-9/2x1	2 form A	8-4441-832-1	170 ± 10%		4,3	12,3
K-9/9x1	3 form A	8-4441-833-1	150 ± 10%		4,3	12,1
K-9/4x1	4 form A	8-4441-834-1	85 ± 10%		4,3	10,2
K-9/1x1	1 form A	8-4441-831-2	560 ± 15%	9	5,8	18,3
K-9/2x1	2 form A	8-4441-832-2	345 ± 15%		6,6	17,3
K-9/9x1	3 form A	8-4441-833-2	300 ± 10%		6,3	17,1
K-9/4x1	4 form A	8-4441-834-2	190 ± 10%		6,3	15,2
K-9/1x1	1 form A	8-4441-831-3	1000 ± 15%	12	8,3	24,6
K-9/2x1	2 form A	8-4441-832-3	620 ± 15%		8,7	23,0
K-9/9x1	3 form A	8-4441-833-3	560 ± 15%		8,7	22,7
K-9/4x1	4 form A	8-4441-834-3	290 ± 10%		7,7	18,8
K-9/1x1	1 form A	8-4441-831-4	2800 ± 15%	24	13,2	40,0
K-9/2x1	2 form A	8-4441-832-4	1900 ± 15%		14,4	40,0
K-9/9x1	3 form A	8-4441-833-4	2100 ± 15%		17,1	43,0
K-9/4x1	4 form A	8-4441-834-4	1000 ± 15%		16,3	33,0

4. DIMENSIONS AND TERMINAL ARRANGEMENTS

K-9/Nx1

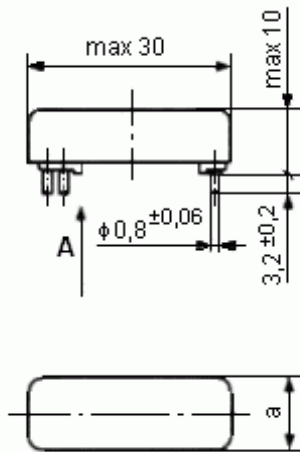

Reed relay	Dimension a (max)
K-9/1x1	10 mm
K-9/2x1	12,5 mm
K-9/3x1	15 mm
K-9/4x1	18 mm

View from the bottom side of relay

$$m = 2,54$$

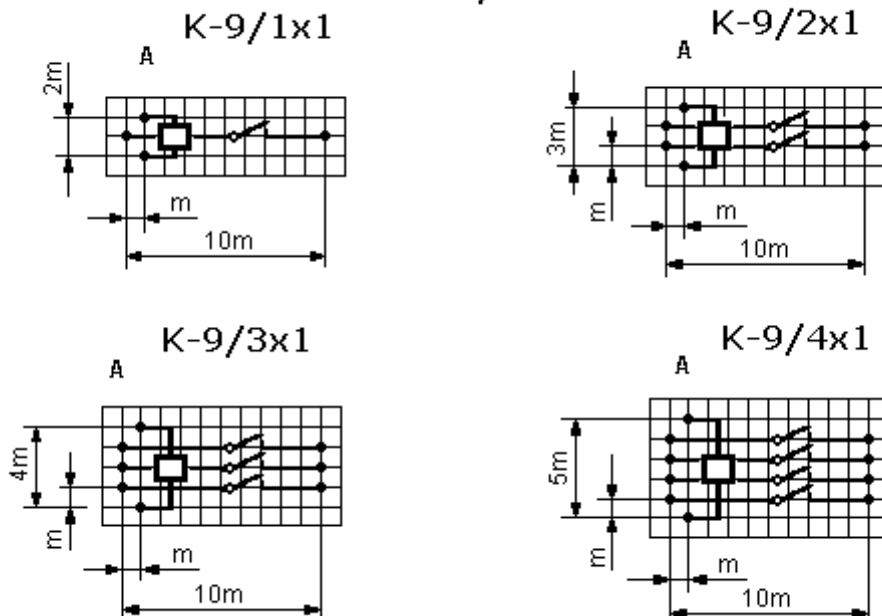

Ordering Information

When ordering relay please specify:

- symbol of relay
- index number

Recommendation for users

When mounting into printed circuit boards, it is advisable to observe the following points to avoid damage to the relays:

- the time of continuous heating of terminals during soldering should not exceed 5 s,
- the soldering iron should not press on terminals during soldering,
- the relays should not be mounted near sources of strong magnetic fields, e.g. transformers, permanent magnets etc.,
- the relays should operate at nominal supply voltages.



PIT-RADWAR S.A.
WROCLAW DIVISION

50-425 Wrocław, ul. Krakowska 64, Poland
tel. (+48) 71/342-65-54, fax (+48) 71/342-58-59
e-mail: sales@dolam.pl
www.dolam.pl

Reed relays type K-93/Nx1

This product is in accordance with RoHs

**Reed relays with 1 to 4 form A contacts
(normally open) for PCB's.**

PARAMETERS	Unit	TYPE
		K-93/Nx1

1 CONTACT PARAMETERS

Switching power	max	W, VA	10
Switching voltage	max	V _{DC}	200
Switching current	max	A	0,5
Contact resistance	max	mA	200
Life expectancy at 20V _{DC} , 500mA		operations	3x10 ⁶

2. RELAY PARAMETERS

Operating voltage range		V	see p. 3
Coil resistance		A	see p. 3
Operate time incl. bounce time for :			
K-93 / 1 x 1			1,2
K-93 / 2 x 1	max	ms	1,5
K-93 / 3 x 1			1,8
K-93 / 4 x 1			2,1
Release time	max	ms	0,3
Test voltage:			
contact			300
contact/ contact	min	V _{AC}	500
contact/ coil			500
Insulation resistance	min	A	10 ⁹
Admissible ambient temperature			-40°C ÷ 85°C

3. LIST OF COILS AND OPERATING VOLTAGE RANGE

Symbol of relay	Contact arrangement	Index No	Coil resistance R _N [A] t = 20°C	Supply voltage, t = 20°C		
				U _N [V]	U _{MIN} [V]	U _{MAX} [V]
K-93/1x1	1 form A	8-4441-845-1	265 ± 15%	6	4,3	17,5
K-93/2x1	2 form A	8-4441-846-1	170 ± 10%		4,3	16,2
K-93/3x1	3 form A	8-4441-847-1	150 ± 10%		4,3	15,7
K-93/4x1	4 form A	8-4441-848-1	85 [®] 10%		4,3	12,6
K-93/1x1	1 form A	8-4441-845-2	560 ± 15%	9	5,8	25,4
K-93/2x1	2 form A	8-4441-846-2	345 ± 15%		6,6	22,5
K-93/3x1	3 form A	8-4441-847-2	300 ± 10%		6,3	22,0
K-93/4x1	4 form A	8-4441-848-2	190 ± 10%		6,3	18,3
K-93/1x1	1 form A	8-4441-845-3	1000 ± 15%	12	8,3	33,3
K-93/2x1	2 form A	8-4441-846-3	620 ± 15%		8,7	30,2
K-93/3x1	3 form A	8-4441-847-3	560 ± 15%		8,7	29,4
K-93/4x1	4 form A	8-4441-848-3	290 ± 10%		7,7	23,3
K-93/1x1	1 form A	8-4441-845-4	2800 ± 15%	24	13,2	56,7
K-93/2x1	2 form A	8-4441-846-4	1900 ± 15%		14,4	52,8
K-93/3x1	3 form A	8-4441-847-4	2100 ± 15%		17,1	56,7
K-93/4x1	4 form A	8-4441-848-4	1000 ± 15%		16,3	41,7

4. DIMENSIONS AND TERMINAL ARRANGEMENTS

K-93/Nx1

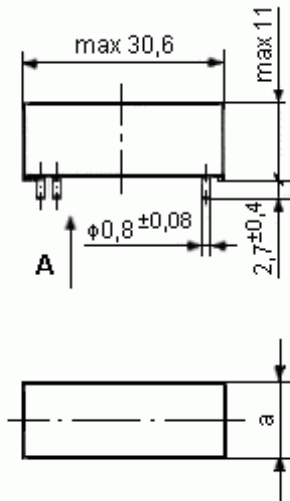

Reed relay	Dimension a (max)
K-93/1x1	11 mm
K-93/2x1	13,5 mm
K-93/3x1	16 mm
K-93/4x1	19,2 mm

View from the bottom side of relay

$$m = 2,54$$

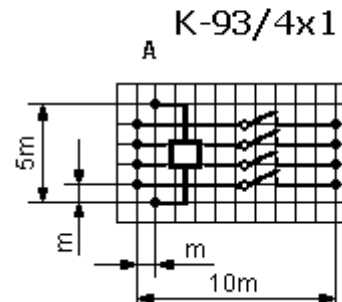
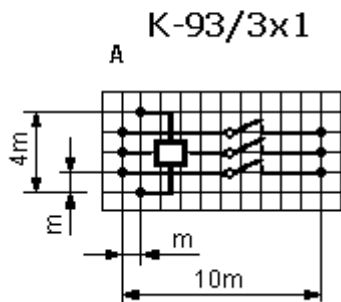
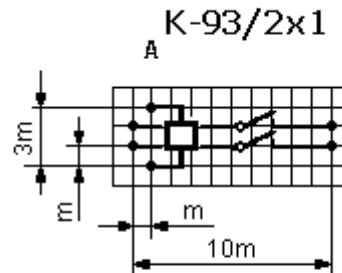
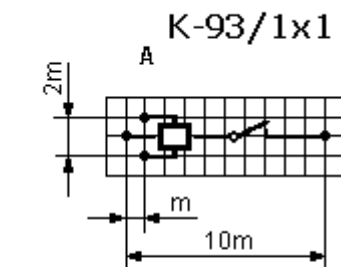

Ordering Information

When ordering relay please specify:

- symbol of relay
- index number

Recommendation for users

When mounting into printed circuit boards, it is advisable to observe the following points to avoid damage to the relays:

- the time of continuous heating of terminals during soldering should not exceed 5 s,
- the soldering iron should not press on terminals during soldering,
- the relays should not be mounted near sources of strong magnetic fields, e.g. transformers, permanent magnets etc.,
- the relays should operate at nominal supply voltages.